

# Hydro-X Pro

## Advanced Version of Hydro-X System

The Hydro-X Pro ( HCS-2 ) is an upgraded main controller that features a 10.1 inch touch screen. The main controller HCS-2 comes standard with a 4-in-1 ( Temp / Humidity / CO2 / Photocell ) sensor. It is backwards compatible with all current Hydro-X control & device modules and provides greater flexibility and much more advanced functions.



HCS-2 for Hydro-X Control System

## Connection

### Daisy Chain Connection

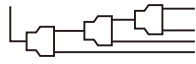

The sensors and control modules ( device stations ) are connected to the HCS-2 with a standard RJ12 cable and RJ12 Y-splitters, making installation as simple as plug-and-play. The modules are “daisy-chained” together using the RJ12 cables allowing for flexible installation, and future expansion. To make installation even easier, you can also use the SPH-1 8-port hub instead of using the Y-splitters.

## Remote Control

### Web-based software



Besides the onboard user interface / touch-screen, the Trolmaster app will provide real-time data and user notifications from the HCS-2. The HCS-2 also offers a free web-based software program that allows remote control and monitoring through the internet with any desktop, laptop, smartphone or tablet. To access the online software, simply login with your app email and password at [pro.trolmaster.com](http://pro.trolmaster.com)

## Specifications

### HYDRO-X PRO (HCS-2)

#### Product Capacity

<b>Sensors</b>	Maximum 50/pcs
<b>Devices</b>	Maximum 50/pcs
<b>Light Channel</b>	2
<b>Amount of Lights</b>	Unlimited

#### Environment Setting

<b>Temperature</b>	40°F-100°F
<b>Humidity</b>	20-99%
<b>CO2</b>	300-2500PPM
<b>Light Intensity</b>	10-2000 PPFD

\*current setting range

#### Operating Requirements

<b>Temperature</b>	32 °F-120 °F
<b>Humidity</b>	5% to 90% RH

#### Power Supply

<b>Supply Voltage</b>	100-240VAC, 50/60Hz, 0.5A
-----------------------	------------------------------

#### Dimensions & G.W.

<b>Dimensions</b>	380*270*85mm 0.5A
<b>Approx. G.W.</b>	2.98kg

#### Display & Control

<b>Size</b>	10.1' LED Screen
<b>Control</b>	Touch Screen Control
<b>Language</b>	English (International)
<b>USB/micro-SD</b>	Save/Copy/Import/ Export data

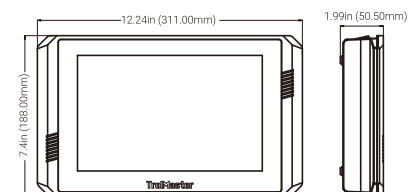

# Hydro-X Pro

## Unique Features

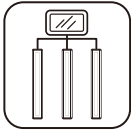

### Group Control

(Up to 10 Groups) of lighting control for ThinkGrow brand LEDs allows a customized combination of light settings for up to 10 separate groups of LEDs on a single HCS-2 controller.

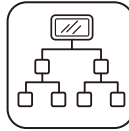

### Multiple Activation Conditions

Each plug-in module can be programmed with multiple conditions, allowing almost unlimited control options on the device modules.

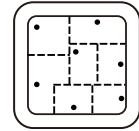

### Multiple Sub-zone Control

Sub-Zones can be created to ensure a complete and balanced growing environment by allowing separate control on device groups by assigning specific sensors to control specific device modules.



### Calendar Control Presets & Customized Reminders

Allow users to "build" their own custom multi-week crop schedules and program reminders.

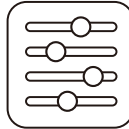

### Customized Ramp Up/Down Environment Control

Allows parameters to be changed gradually and avoid instant drastic changes to better mimic the natural outdoor conditions.



### DLI (Daily Light Integral) Control and Monitoring

Can be used to calculate the exact amount of light needed based on the PPF to enhance growth rates and to save energy.



### Spray Mode

Will automatically reduce the power to the lights, or turn lights off ... lower fan speed or turn off equipment when foliar spraying, and then turn the equipment back on to the initial setting after a period of time.

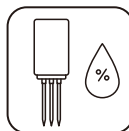

### Media Moisture Level

Percentage of water or nutrients within the growing medium can be monitored with the WCS-1 Water Sensor.



### Cloud Effect

The HCS-2 can simulate natural cloud movements to mimic a natural outdoor environment which ensures less stress on the plants and will also save electricity.

## Lighting Control

### With Hydro-X System

### Light Control

The Hydro-X Pro can control almost all horticultural lighting systems ( LED / HID ) in the market using one of Trolmaster's LMA series of lighting adapters. Two separate lighting control channels allow users to control two different lighting systems with separate setpoints.

When used with Hydro-X Pro, the LMA-T can provide user's ultimate control over ThinkGrow LED ( i.e. individual control on 4 different spectrums of the PLUS series ), and allows users to adjust and control the light spectrum according to their individual needs.

### MBS-PAR Sensor

The PAR sensor can be incorporated into the Hydro-X Pro system to provide measurement of "PAR" ( Photosynthetically Active Radiation ). After entering the value of the desired amount of PPF to HCS-2, the PPF sensor will automatically increase or decrease the output level of the supplemental lighting systems to continuously maintain the exact lighting level ( in terms of PPF ) selected.



# 4-in-1 Sensor MBS-PRO

Temp/Humidity/CO2/Photocell

This sensor will measure air temperature, humidity, CO2 ( PPM ) and has a photocell to detect Day or Night operation, making it a perfect all-in-one environmental sensor. The sensor will detect the environmental parameters then send the collected data back to the Hydro-X Pro. By using different modules connected to the Hydro-X Pro system, the controller will then send signals to the modules and control those devices based on the environmental readings provided by the 4-in-1 sensor.

\* Photocell sensor detects only the presence of light, not light intensity.



## Temperature

Temperature can be regulated with the modules by controlling the temperature control devices.

For example, the ARS-1 can control mini-split AC, TS-2 can control HVAC system etc.



## Humidity

Humidity can be regulated with the modules by controlling the humidity control devices.

For example, the HS-1 can control dehumidifiers, TSH-1 can control EC fans etc.

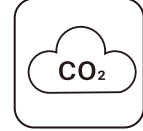

## CO2

CO2 level can be regulated with the modules by controlling the CO2 control devices.

For example, the DSC-1 can control CO2 tank regulators and CO2 generators etc.

All DS modules are universal and multi-purposed in the Hydro-X Pro system.

## Other Control & Sensor

For Different Circumstances

### Other Control

There are other modules that can be used to control devices in different circumstances in accordance with user's need.

For instance, devices like fans or pumps can be controlled based on time rather than Temperature, Humidity, and CO2 with the Timer Control module the DSP-1.

The DCC-1, DSV-1 and the 4RS-1 Expander Station offer dual condition control, low voltage control and multiple device control respectively.

### Other Sensor Alert

These 3 sensors: MBS-SD, WD-2, WCS-1, are used to detect smoke, water leakage and abnormal moisture level of medium. Warning alerts will be sent to users on the TrolMaster App when abnormal conditions are detected to alert them about potential problems before things get out of hand.

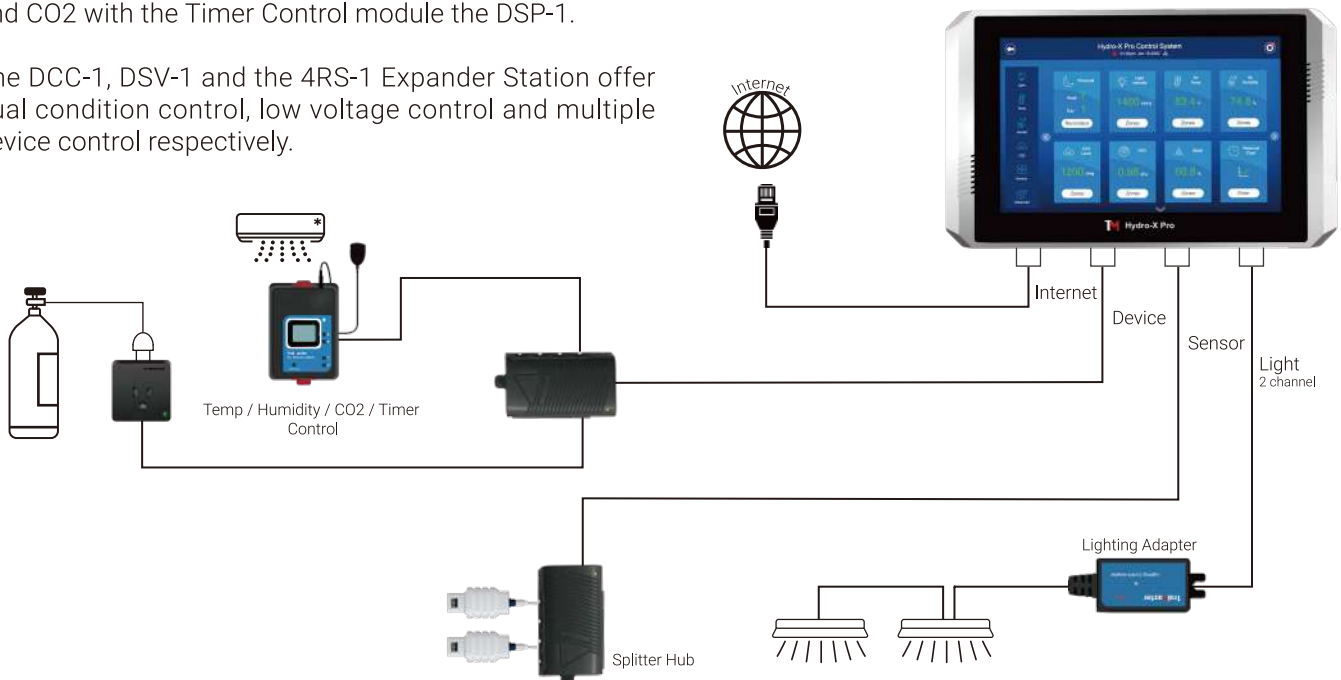

# Hydro-X PRO

## Control System

All DS modules are universal and multiple purposes in the Hydro-X PRO system

Model and part numbers: DS-1, DS-2, DS-1, DS-1, DS-1, DS-1, DS-1, DS-1, DS-1, DS-1

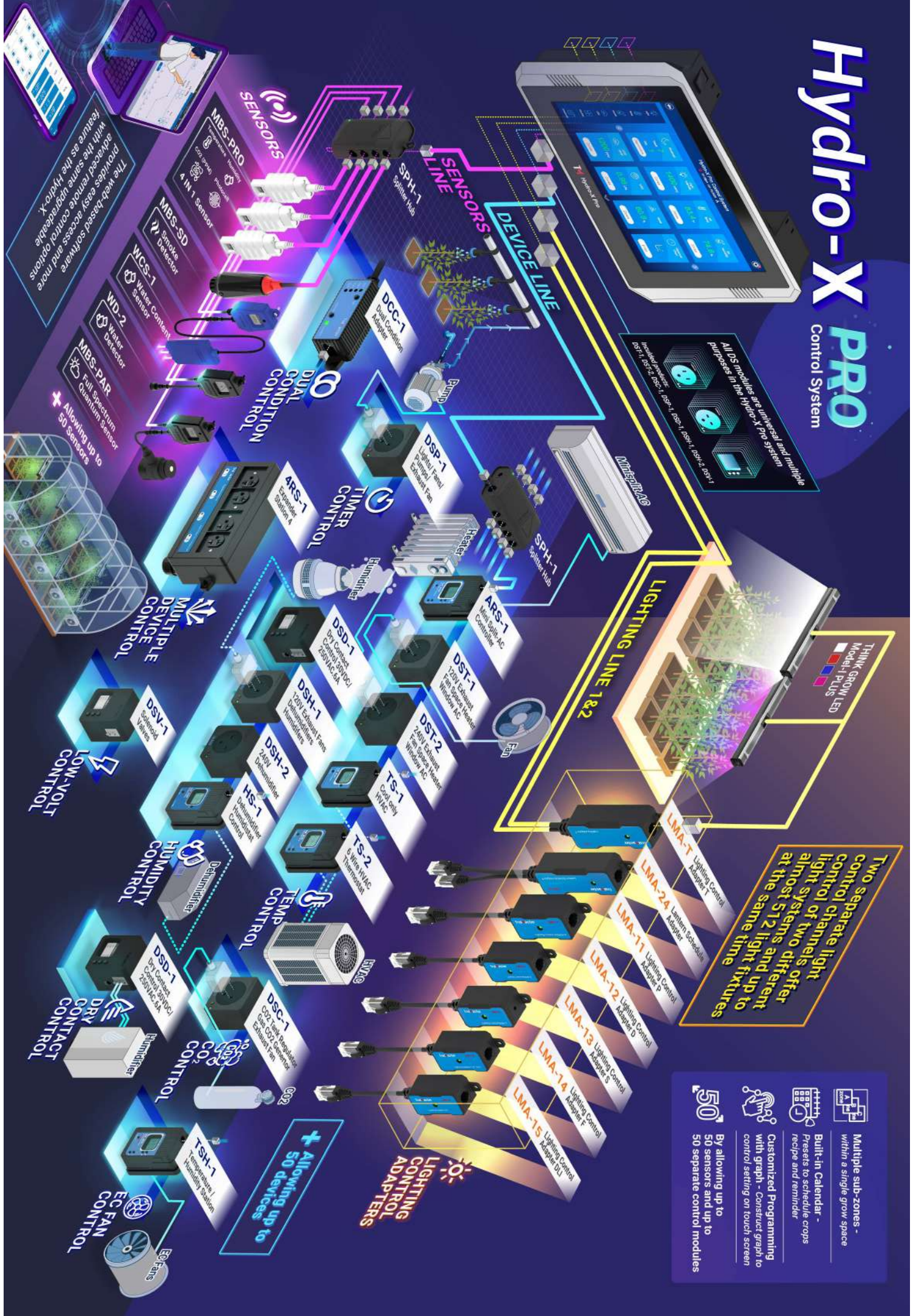

The web-based software provides easy access and more advanced remote control options feature as the Hydro-X.

Two separate light control channels offer almost 512 light fixtures at the same time

Allowing up to 50 devices

- Multiple sub-zones - within a single grow space
- Built-in Calendar - Presets to schedule crops recipe and reminder
- Customized Programming with graph - Construct graph to control setting on touch screen
- By allowing up to 50 sensors and up to 50 separate control modules